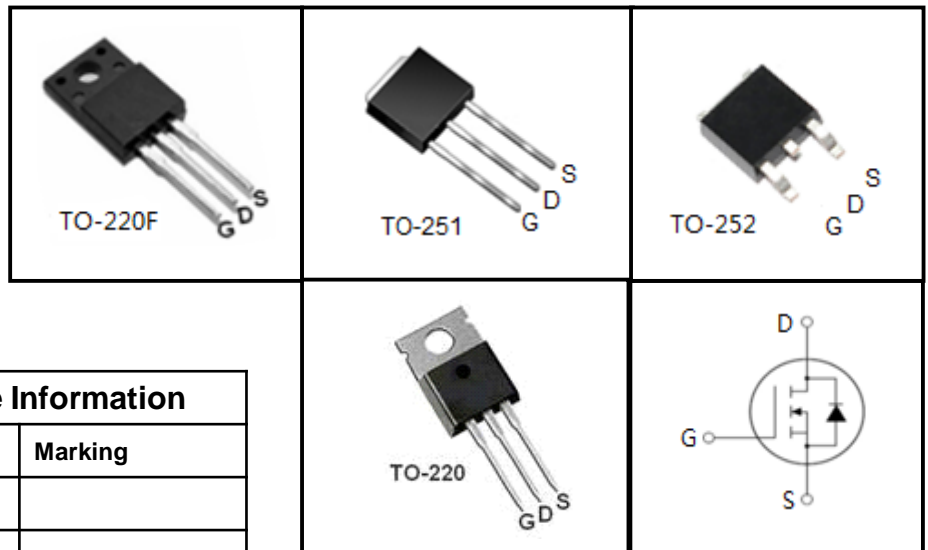


### FEATURES

- Fast switching
- 100% avalanche tested
- Improved dv/dt capability

### APPLICATIONS

- Switch Mode Power Supply (SMPS)
- Uninterruptible Power Supply (UPS)
- Power Factor Correction (PFC)



### Device Marking and Package Information

Device	Package	Marking
LM8N25F	TO-220F	
LM8N25P	TO-220	
LM8N25U	TO-251	
LM8N25D	TO-252	

### Absolute Maximum Ratings $T_C = 25^\circ\text{C}$ , unless otherwise noted

Parameter	Symbol	Value				Unit
		TO-220F	TO-220	TO-251	TO-252	
Drain-Source Voltage ( $V_{GS} = 0V$ )	$V_{DSS}$	250				V
Continuous Drain Current	$I_D$	8				A
Pulsed Drain Current (note1)	$I_{DM}$	32				A
Gate-Source Voltage	$V_{GSS}$	$\pm 30$				V
Single Pulse Avalanche Energy (note2)	$E_{AS}$	218				mJ
Avalanche Current (note1)	$I_{AS}$	6.6				A
Repetitive Avalanche Energy (note1)	$E_{AR}$	130				mJ
Power Dissipation ( $T_C = 25^\circ\text{C}$ )	$P_D$	54	83			W
Operating Junction and Storage Temperature Range	$T_J, T_{stg}$	-55~+150				$^\circ\text{C}$

### Thermal Resistance

Parameter	Symbol	Value				Unit
		TO-220F	TO-251	TO-252	TO-220	
Thermal Resistance, Junction-to-Case	$R_{thJC}$	2.3	1.5			K/W
Thermal Resistance, Junction-to-Ambient	$R_{thJA}$	62.5	60			

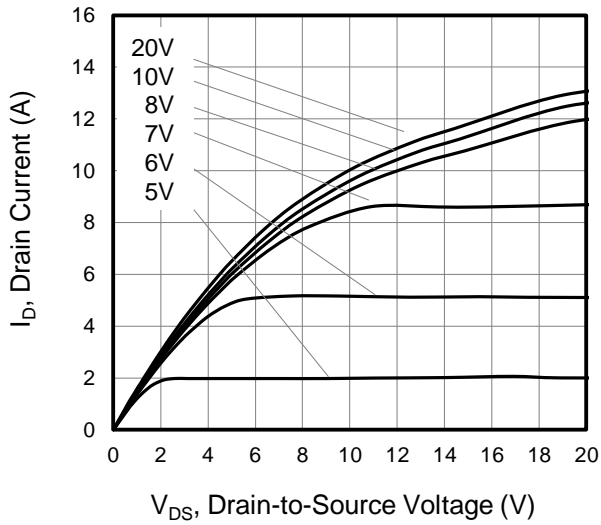
Specifications $T_J = 25^\circ\text{C}$ , unless otherwise noted						
Parameter	Symbol	Test Conditions	Value			Unit
			Min.	Typ.	Max.	
<b>Static</b>						
Drain-Source Breakdown Voltage	$V_{(BR)DSS}$	$V_{GS} = 0V, I_D = 250\mu A$	250	--	--	V
Zero Gate Voltage Drain Current	$I_{DSS}$	$V_{DS} = 250V, V_{GS} = 0V, T_J = 25^\circ\text{C}$	--	--	1	$\mu A$
Gate-Source Leakage	$I_{GSS}$	$V_{GS} = \pm 30V$	--	--	$\pm 100$	nA
Gate-Source Threshold Voltage	$V_{GS(th)}$	$V_{DS} = V_{GS}, I_D = 250\mu A$	2	--	4	V
Drain-Source On-Resistance (Note3)	$R_{DS(on)}$	$V_{GS} = 10V, I_D = 4.0A$	--	0.45	0.52	$\Omega$
<b>Dynamic</b>						
Input Capacitance	$C_{iss}$	$V_{GS} = 0V,$ $V_{DS} = 25V,$ $f = 1.0\text{MHz}$	--	467	--	pF
Output Capacitance	$C_{oss}$		--	79	--	
Reverse Transfer Capacitance	$C_{rss}$		--	39	--	
Total Gate Charge	$Q_g$	$V_{DD} = 200V, I_D = 8.0A,$ $V_{GS} = 10V$	--	31	--	nC
Gate-Source Charge	$Q_{gs}$		--	1.5	--	
Gate-Drain Charge	$Q_{gd}$		--	15	--	
Turn-on Delay Time	$t_{d(on)}$	$V_{DD} = 125V, I_D = 8.0A,$ $R_G = 25\Omega$	--	34	--	ns
Turn-on Rise Time	$t_r$		--	8	--	
Turn-off Delay Time	$t_{d(off)}$		--	185	--	
Turn-off Fall Time	$t_f$		--	53	--	
<b>Drain-Source Body Diode Characteristics</b>						
Continuous Body Diode Current	$I_S$	$T_C = 25^\circ\text{C}$	--	--	8	A
Pulsed Diode Forward Current	$I_{SM}$		--	--	32	
Body Diode Voltage	$V_{SD}$	$T_J = 25^\circ\text{C}, I_{SD} = 4.0A, V_{GS} = 0V$	--	--	1.4	V
Reverse Recovery Time	$t_{rr}$	$V_{GS} = 0V, I_S = 8.0A,$ $di_F/dt = 100A/\mu s$	--	158	--	ns
Reverse Recovery Charge	$Q_{rr}$		--	0.8	--	$\mu C$

### Notes

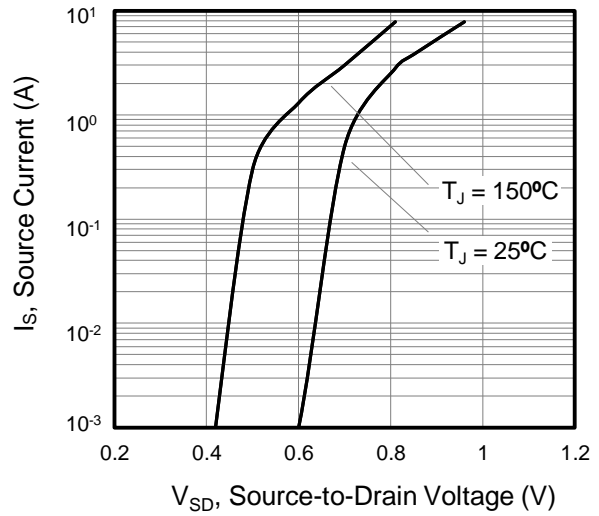
1. Repetitive Rating: Pulse width limited by maximum junction temperature
2.  $L = 10\text{mH}, V_{DD} = 30V, R_G = 25\Omega$ , Starting  $T_J = 25^\circ\text{C}$
3. Pulse Test: Pulse width  $\leq 300\mu s$ , Duty Cycle  $\leq 1\%$

## Typical Characteristics $T_J = 25^\circ\text{C}$ , unless otherwise noted

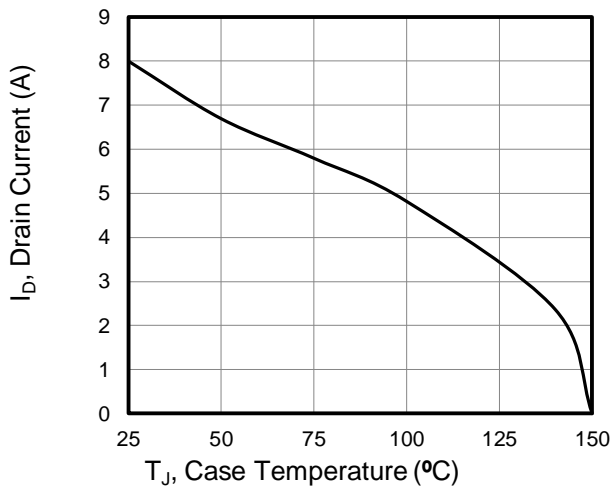
**Figure 1. Output Characteristics ( $T_J = 25^\circ\text{C}$ )**



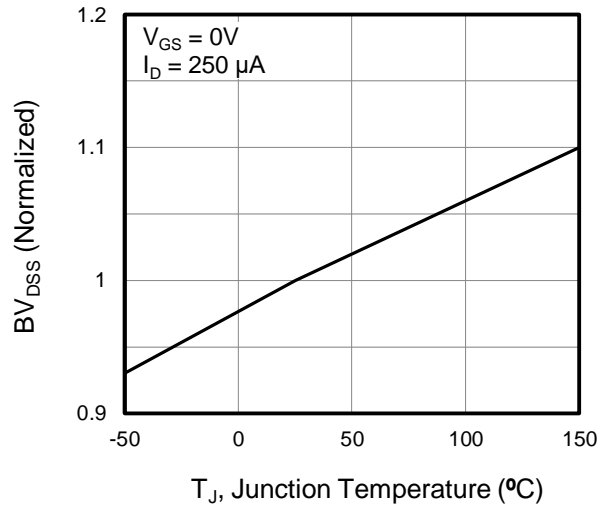
**Figure 2. Body Diode Forward Voltage**



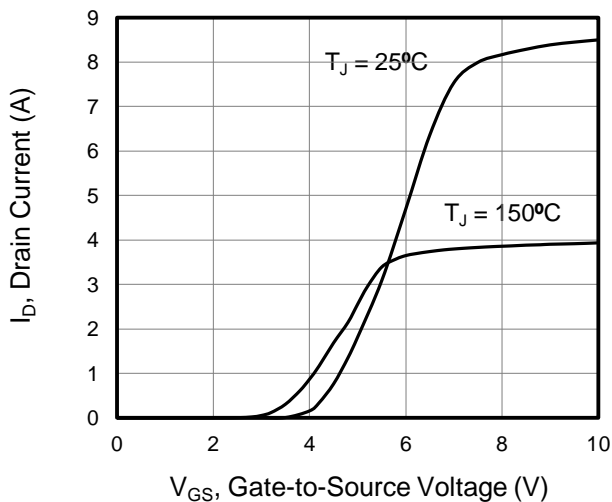
**Figure 3. Drain Current vs. Temperature**



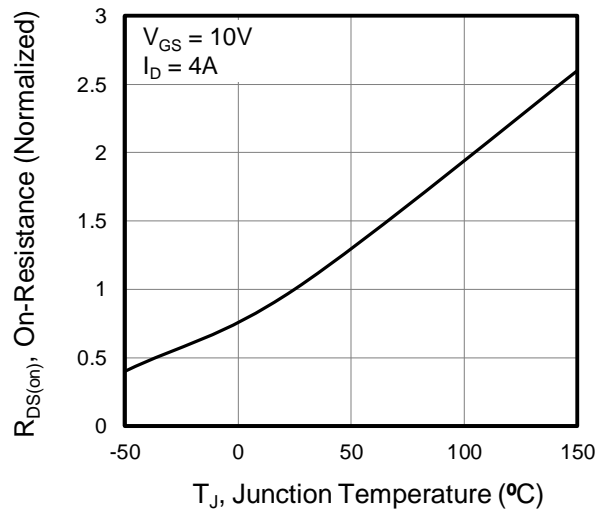
**Figure 4.  $BV_{DSS}$  Variation vs. Temperature**



**Figure 5. Transfer Characteristics**

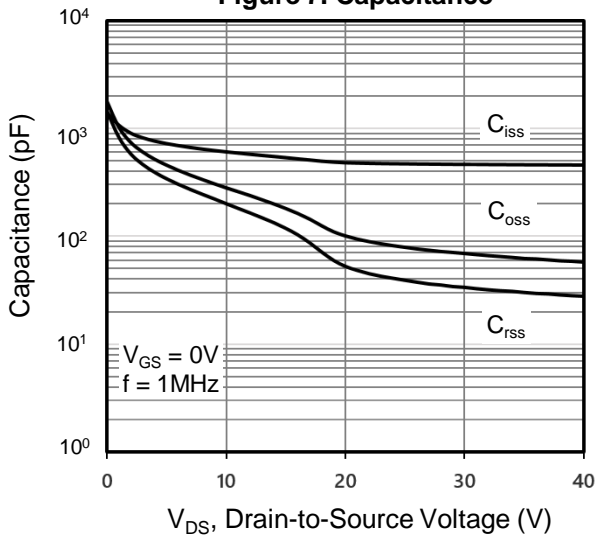


**Figure 6. On-Resistance vs. Temperature**

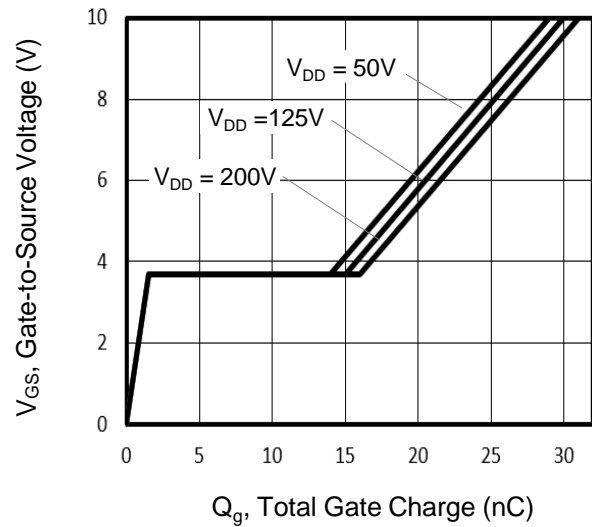


## Typical Characteristics $T_J = 25^\circ\text{C}$ , unless otherwise noted

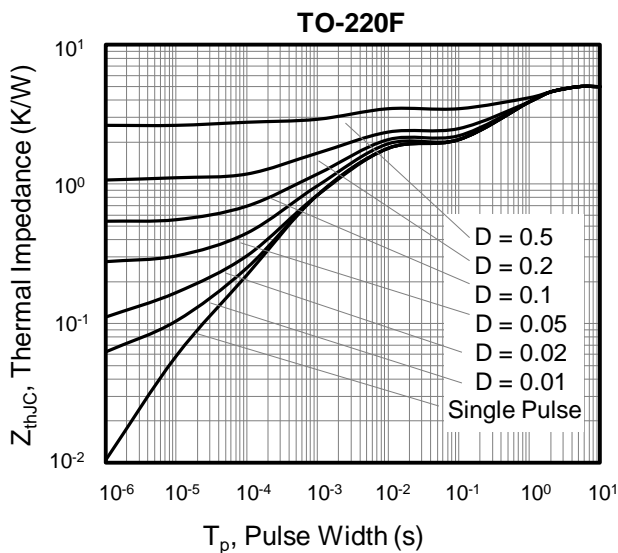
**Figure 7. Capacitance**



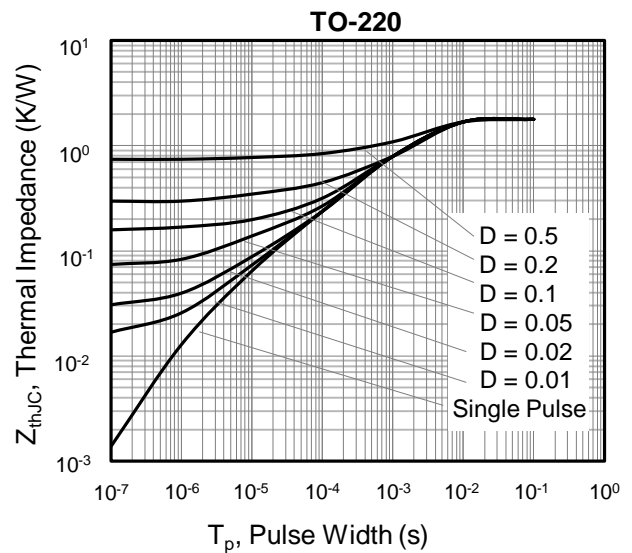
**Figure 8. Gate Charge**



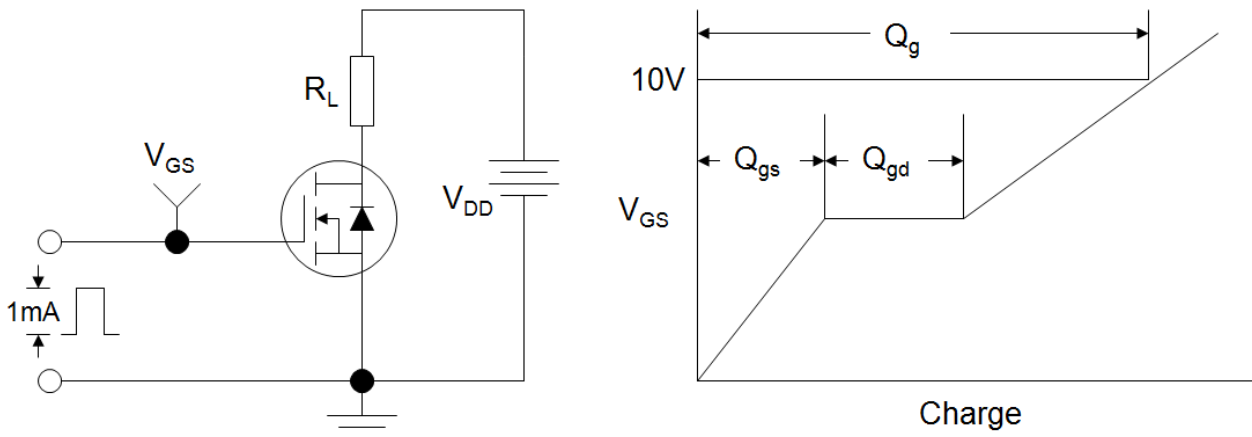
**Figure 9. Transient Thermal Impedance**



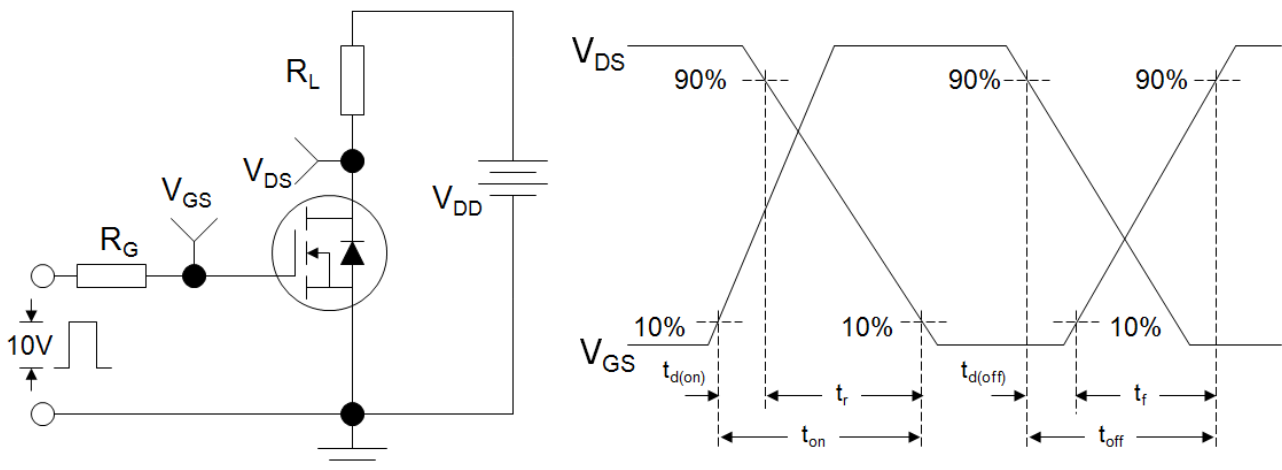
**Figure 10. Transient Thermal Impedance**



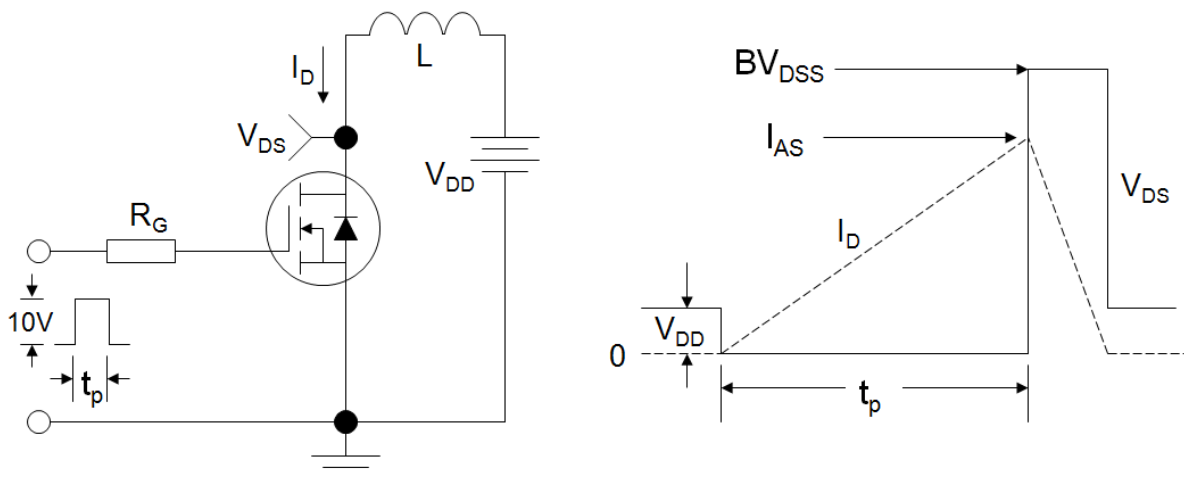
**Figure A: Gate Charge Test Circuit and Waveform**



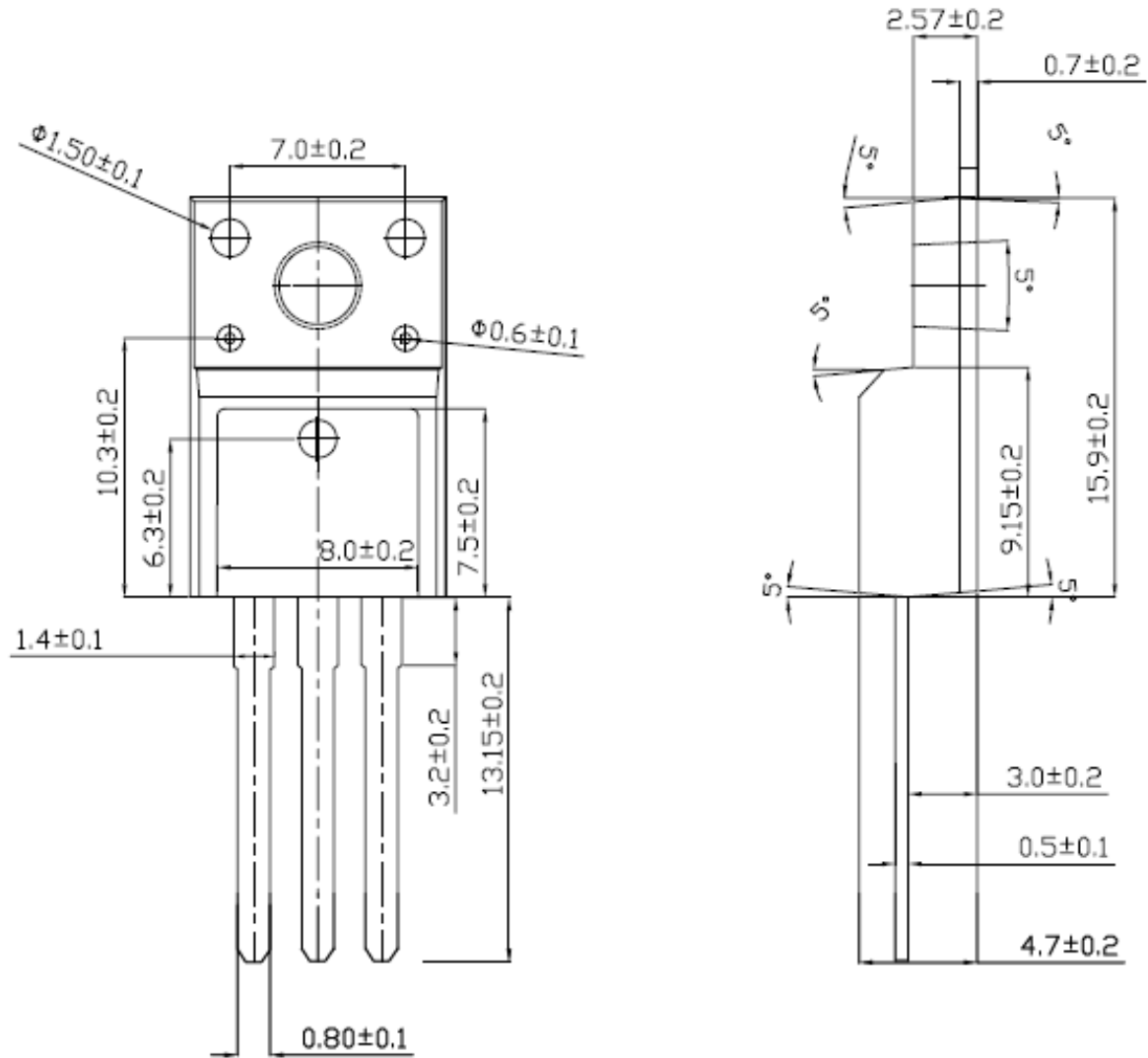
**Figure B: Resistive Switching Test Circuit and Waveform**



**Figure C: Unclamped Inductive Switching Test Circuit and Waveform**



TO-220F







TO-252

