

Description

The LM3D40N10 uses advanced trench technology to provide excellent $R_{DS(ON)}$, low gate charge and operation with gate voltages as low as 4.5V. This device is suitable for use as a Battery protection or in other Switching application.

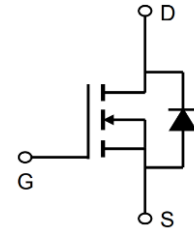

General Features

$V_{DS} = 100V$ $I_D = 40A$

$R_{DS(ON)} < 25m\Omega$ @ $V_{GS}=10V$ (Typ. 14m Ω)

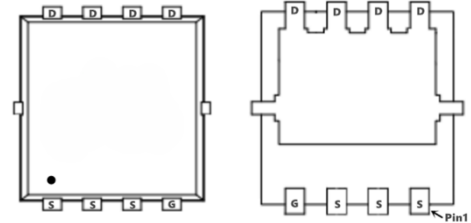

Application

- Consumer electronic power supply
- Motor control
- Synchronous-rectification
- Isolated DC

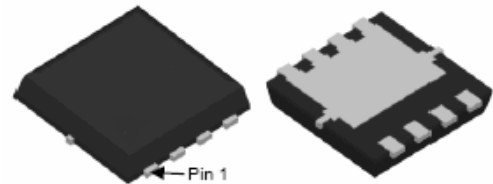

Package Marking and Ordering Information

Device	Device Marking	Device Package	Reel Size	Tape width	Quantity
LM3D40N10	AON7296	DFN3.3X3.3	-	-	5000 units

Absolute Maximum Ratings ($T_c=25^\circ C$ unless otherwise noted)

Symbol	Parameter	Rating	Units
V _{DS}	Drain source voltage	100	V
V _{GS}	Gate source voltage	±20	V
I _D	Continuous drain current ¹⁾ , $T_c=25^\circ C$	40	A
I _{D, pulse}	Pulsed drain current ²⁾ , $T_c=25^\circ C$	120	A
P _D	Power dissipation ³⁾ , $T_c=25^\circ C$	71	W
E _{AS}	Single pulsed avalanche energy ⁵⁾	57	mJ
T _{stg} , T _j	Operation and storage temperature	-55 to 150	°C
R θ JC	Thermal resistance, junction-case	1.76	°C/W
R θ JA	Thermal resistance, junction-ambient ⁴⁾	62	°C/W

Electrical Characteristics (T_J=25 °C, unless otherwise noted)

Symbol	Parameter	Test condition	Min.	Typ.	Max.	Unit
BVDSS	Drain-source breakdown voltage	V _{GS} =0 V, I _D =250 μA	100	107		V
VGS(th)	Gate threshold voltage	V _{DS} =V _{GS} , I _D =250 μA	1.2	1.5	2.5	V
RDS(ON)	Drain-source on-state resistance	V _{GS} =10 V, I _D =10 A		14	25.0	mΩ
RDS(ON)	Drain-source on-state resistance	V _{GS} =4.5 V, I _D =7 A		18	30.0	mΩ
IGSS	Gate-source leakage current	V _{GS} =±20 V			±100	nA
IDSS	Drain-source leakage current	V _{DS} =100 V, V _{GS} =0 V			1	uA
Ciss	Input capacitance	V _{GS} =0 V, V _{DS} =50 V, f=100 kHz		1003.9		pF
Coss	Output capacitance			185.4		pF
Crss	Reverse transfer capacitance			9.8		pF
td(on)	Turn-on delay time	V _{GS} =10 V, V _{DS} =50 V, R _G =10 Ω, I _D =5 A		16.6		ns
t _r	Rise time			3.8		ns
td(off)	Turn-off delay time			75.5		ns
t _f	Fall time			46		ns
Q _g	Total gate charge	I _D =5 A, V _{DS} =50V, V _{GS} =10V		16.2		nc
Q _{gs}	Gate-source charge			2.8		nc
Q _{gd}	Gate-drain charge			4.1		nc
Vplateau	Gate plateau voltage			3		V
I _S	Diode forward current	V _{GS} <V _{th}		30		A
ISP	Pulsed source current			90		A
trr	Reverse recovery time	I _S =1A, di/dt=100 A/μs	49			ns
Q _{rr}	Reverse recovery charge		61.8			nc
Irrm	Peak reverse recovery current		2.4			A

Note :

- 1、 Calculated continuous current based on maximum allowable junction temperature.
- 2、 Repetitive rating; pulse width limited by max. junction temperature.
- 3、 Pd is based on max. junction temperature, using junction-case thermal resistance.
- 4、 The value of R_{θja} is measured with the device mounted on 1 in 2 FR-4 board with 2oz. Copper, in a still air environment with T_a=25 °C.
- 5、 V_{DD}=50 V, R_G=25 Ω, L=0.3 mH, starting T_J=25 °C.

Typical Electrical and Thermal Characteristics

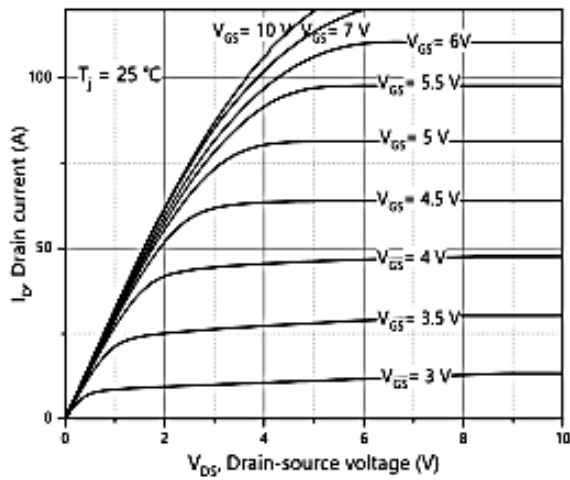

Figure 1, Typ. output characteristics

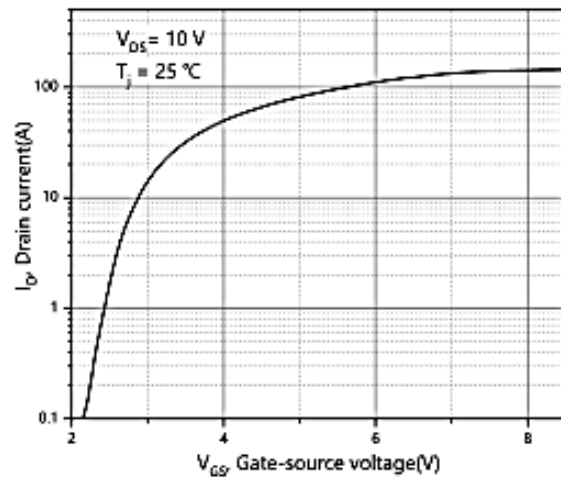

Figure 2, Typ. transfer characteristics

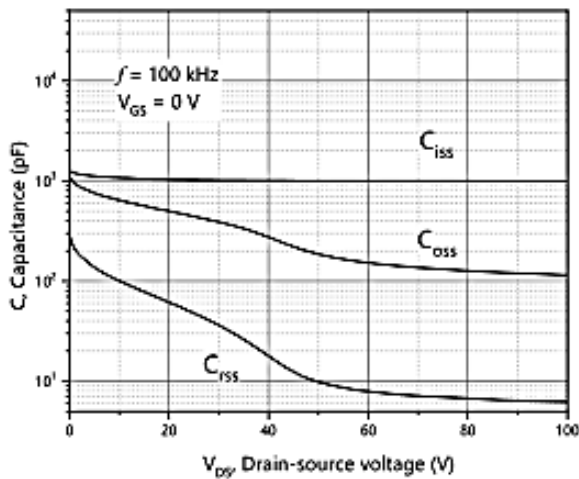

Figure 3, Typ. capacitances

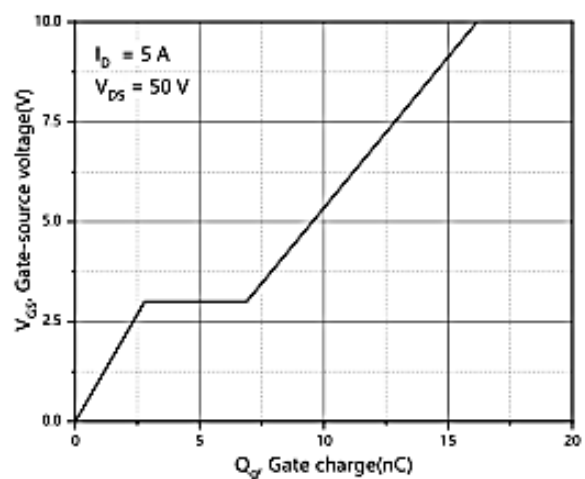

Figure 4, Typ. gate charge

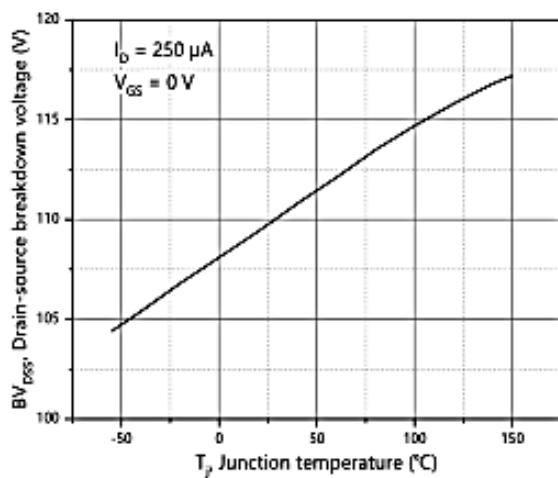

Figure 5, Drain-source breakdown voltage

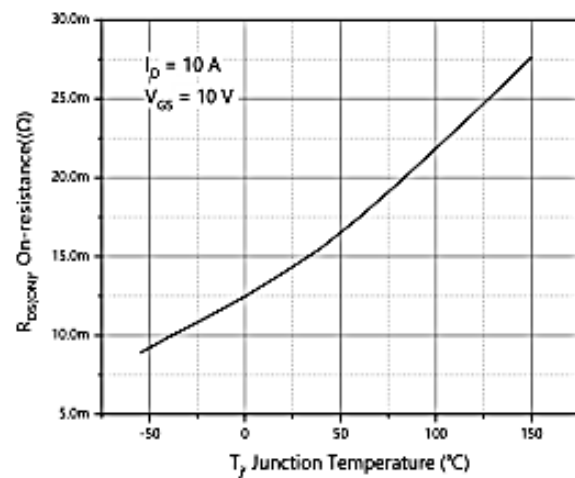

Figure 6, Drain-source on-state resistance

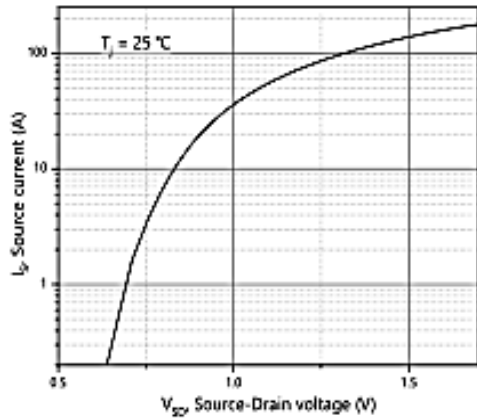

Figure 7, Forward characteristic of body diode

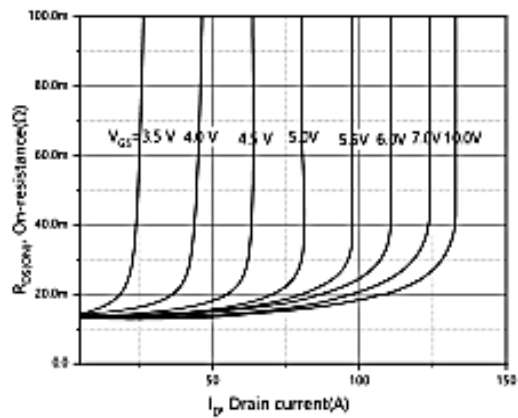

Figure 8, Drain-source on-state resistance

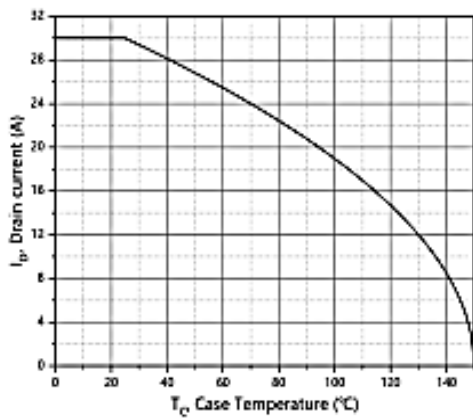

Figure 9, Drain current

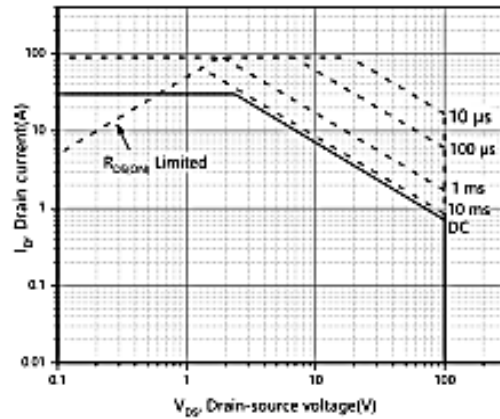

Figure 10, Safe operation area $T_C=25\text{ °C}$

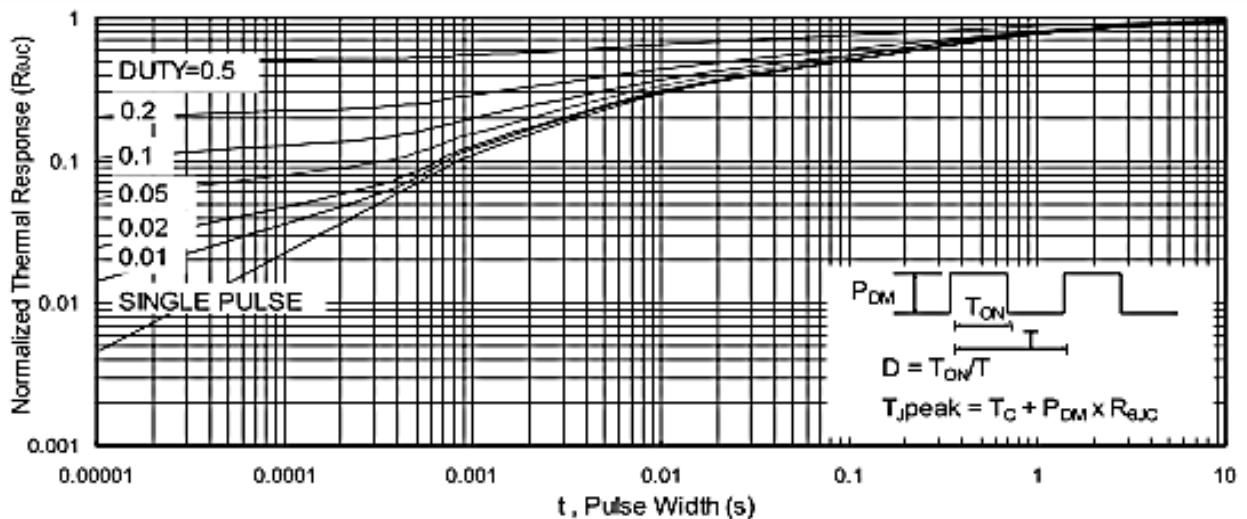
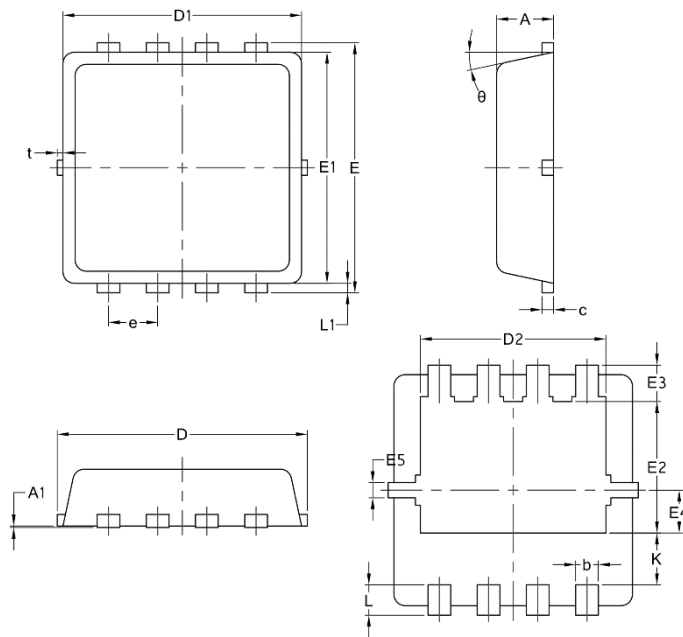

Figure 11, Normalized Maximum Transient Thermal Impedance

Package DFN3.3x3.3



Symbol	Common		
	mm		
	Mim	Nom	Max
A	0.70	0.75	0.85
A1	/	/	0.05
b	0.20	0.30	0.40
c	0.10	0.152	0.25
D	3.15	3.30	3.45
D1	3.00	3.15	3.25
D2	2.29	2.45	2.65
E	3.15	3.30	3.45
E1	2.90	3.05	3.20
E2	1.54	1.74	1.94
E3	0.28	0.48	0.65
E4	0.37	0.57	0.77
E5	0.10	0.20	0.30
e	0.60	0.65	0.70
K	0.59	0.69	0.89
L	0.30	0.40	0.50
L1	0.06	0.125	0.20
t	0	0.075	0.13
Φ	10	12	14